



HF-Regulator II for TL-D lamps

HF-R 236 TL-D EII 220-240V 50/60Hz

High-frequency electronic dimming ballast, using the analog protocol (1-10 V) for TL-D lamps

Product data

• General Characteristics

Interface	1-10V
Application code	EII
Rated Lamptype	TL-D
Rated Number of Lamps	2 piece
Rated Ballast-Lamp Power	36
Line Voltage	220-240 V
Line Frequency	50/60 Hz
Housing	L 360x30x21
Energy Efficiency Index	A1
Lifetime 90% surv.@Tcaselife	50000 hr
Ignition Method	Programmed Start

Battery voltage running lamps	154-276
Overvoltage protection 320Vac	48 hr
Overvoltage protection 350Vac	2 hr
Control input protection	Yes (Basic insulation)
Max ballast on MCB(16A type B)	12 x
Stable lamp operation temp.	- [Not specified]
Crestfactor	1.7 (max) -
Hum and Noise level	Inaudible
Total Harmonic Distortion EUR	5 %

• Operating Characteristics

Automatic restart	Yes
Ignition time	0.2 (max) s
Operating frequency	45 (min), 89 (max) kHz
Mains voltage safety (AC)	-10%/+10%
Mains voltage performance (AC)	-8%/+6%
Inrush current Peak	45 (max) A
Inrush current Width	0.40 ms
Earth leakage current	0.5 (max) mA
Power losses gear	7.3 W
Regulating level power	1%-100%
PowerFactor 100% output power	0.98 -
Battery voltage lamp ignition	196 V

• Wiring Characteristics

Conn.type input terminals	WAGO 251 universal connector [Suitable for both automatic wiring (ALF and ADS) and manual wiring]
Conn.type output terminals	WAGO 251 universal connector [Suitable for both automatic wiring (ALF and ADS) and manual wiring]
Conn.type ctrl input terminals	WAGO 251 universal connector [Suitable for both automatic wiring (ALF and ADS) and manual wiring]
Striplength	8.0-9.0 mm
Dual fixture Master/Slave	- [not specified]
Wcs Control input terminals	0.50-1.00 mm ²
Wcs Input terminals	0.50-1.00 mm ²
Wcs Output terminals	0.50-1.00 mm ²

PHILIPS

HF-Regulator II for TL-D lamps

Wcs auto insertion (ALF/ADS) 0.5 mm²

• Temperature Characteristics

T-ignition 0 (min), 50 (max) C
 T-ambient 10 (min), 50 (max) C
 T-storage -25 (min), 80 (max) C

• Product Dimensions

Length A1 360 mm
 Fixing Hole Distance 350 mm
 Length A2
 Width B1 30 mm
 Height C1 22 mm
 Fixing Hole Diameter 4.2 mm
 D1

• Approval & Application Chars

EMI 9kHz .. 30 MHz EN 55015
 EMI 30 MHz .. 1000MHz EN 55022 level B [Level = Class]
 Safety Standard IEC 61347-2-3
 Performance Standard IEC 60929
 Quality Standard ISO 9000:2000
 Environmental Standard ISO 14001

Harmonic current emissions IEC 61000-3-2
 EMC Immunity IEC 61547
 Vibrations IEC 68-2-6 Fc
 Bumps IEC 68-2-29 Eb
 Humidity EN 61347-2-3 clause 11
 Approval marks ENEC / VDE-EMV
 CE marking Yes
 Temperature marking 110 [Yes]
 Emergency standard IEC 60598-2-22

• Product Data

Order code 913700609366
 Full product code 913700609366
 Full product name HF-R 236 TL-D EII 220-240V 50/60Hz
 Order product name HF-R 236 TL-D EII 220-240V 50/60Hz
 Pieces per pack 1
 Packing configuration 12
 Packs per outerbox 12
 Bar code on pack - EAN1 8711500910158
 Bar code on outerbox - EAN3 8711500910165
 Logistic code(s) - 12NC 913700609366
 Net weight per piece 0.295 kg

Dimensional drawing

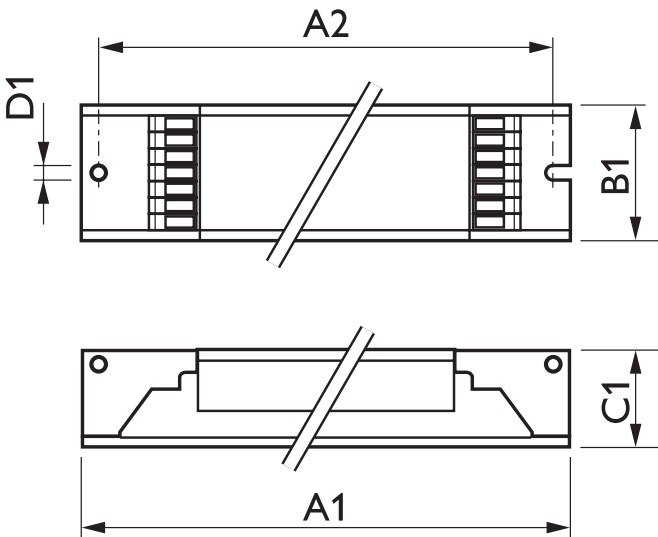

HF-R 236 TL-D EII 220-240V 50/60Hz

Product	A1 (Norm)	A2 (Norm)	B1 (Norm)	C1 (Norm)	D1 (Norm)
HF-R 236 TL-D EII 220-240V 50/60Hz	360	350	30	22	4.2

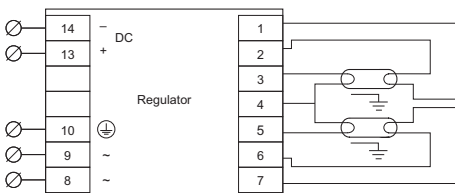

HF-R 2 lamps TL5/PL-L/TL-D



© 2014 Koninklijke Philips N.V. (Royal Philips)
All rights reserved.

Specifications are subject to change without notice. Trademarks are the property of Koninklijke Philips N.V. (Royal Philips) or their respective owners.

www.philips.com/lighting

2014, April 11
data subject to change